

VIEW-A
比例 4:1

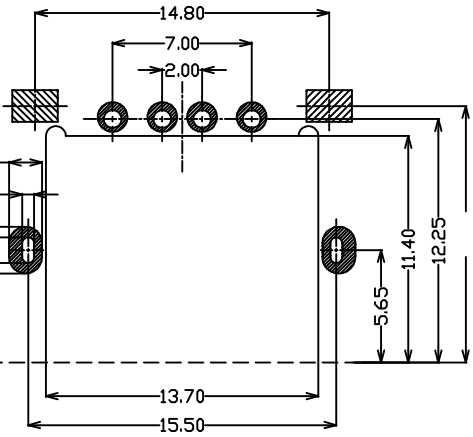

PCB LAYOUT (TOLERANCE: ±0.05)
TOP VIEW (THICKNESS=1.20mm)

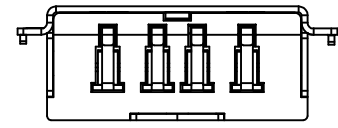
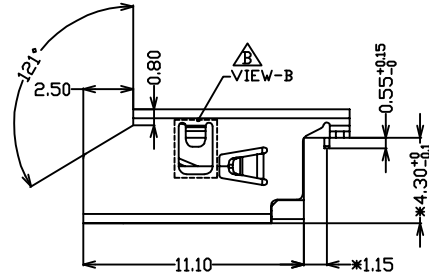
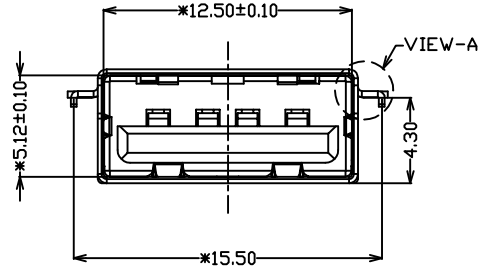
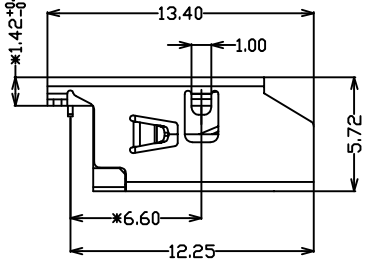

VIEW-B
SCALE 2:1

NOTES:
1.MECHANICAL:
MATING:35N MAX
WITHDRAWAL:10N MIN
DURABILITY:BRASS 1500 CYCLEE MIN
SUS 3000 CYCLES MIN
2.ELECTRICAL:
CURRENT:1.0A MAX
VOLTAGE:30V MAX
WITHSTANDING VOLTAGE:500V AC
CONTACT RESISTANCE:1000MΩ MIN
3.ENVIRONMENTAL:
TEMPERATURE RANGE -55°C ~ +85°C
4.REFLOW SOLDER CAPABLE TO 260°C PER
5.*表示是重點管控尺寸

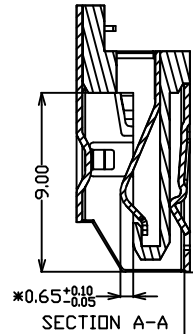
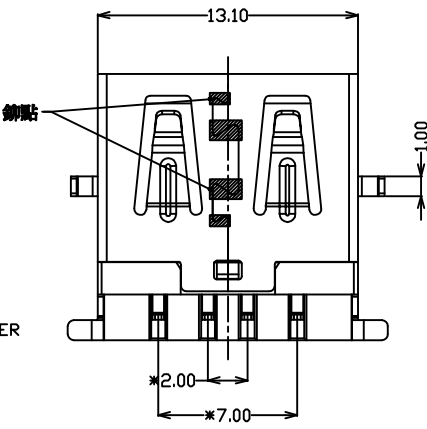

3	CONTACT	C5191R-EH,T=0.25,GOLD FLASH	4
2	SHELL	C2680R-H,T=0.30, PLATING NICKEL ALL	1
1	HOUSING	LCP+30%GF, BLACK	1
NO	DESCRIPTION	SPECIFICATION	□'TY

尚益科技有限公司
JMSCONN TECHNOLOGY CO., LTD.

PROJ	SCALE : F DO NOT SCALE DWG	MOLD NO 20014-TH		
APP		MODEL	FILE NO	REV. X1
CHK		UNIT MM	SHT 1 OF 1	SIZE A4
DGN				
DRW	HSIEH	2016.11.16		